



User Guide for Parents



TABLE OF CONTENTS

SAFETY INFORMATION	1
Network Services	1
Charger and Enhancements	1
MEET THE FIREFLY™ PHONE	2
PREPARE THE PHONE FOR USE	3
Install a SIM Card	3
Charge the Battery	4
GETTING STARTED	5
Power On and Off	5
Display	5
MENUS	6
Menu Choices	8
Using the Menus	9
SETTING UP THE PHONE	10
Set the Time and Date	10
Set Up the Call Keys	11
Load Call Key Numbers from the SIM	14
Call Screening	14
CUSTOMIZING THE PHONE	15
Set the Ring Tones	15
Select Display Colors	15
Select an Animation	16
Change the Charger Lights	16
USING THE PHONE	17
Make a Call	17
Make an Emergency Call	17
Answer a Call	18
Answer a Call with a Waiting Call	18
Send Numbers During a Call	18
Adjust the Volume	19
View the Missed Calls List	19
View the Call Timer	19
Firefly Fireworks™ display and other lights	20
Attach the Backpack Clip	20

HELP YOUR CHILD USE THEIR PHONE	21
MAINTENANCE AND TROUBLESHOOTING	21
Cleaning the phone	21
Use the Manual Reset Option	21
FIREFLY ONE-YEAR LIMITED WARRANTY	22
FCC NOTICE AND SAR STATEMENT	25
U.S. FOOD AND DRUG ADMINISTRATION CONSUMER UPDATE ON MOBILE PHONES	27

Copyright ©2006 Firefly Mobile, Inc.

Firefly and Firefly Fireworks are the exclusive trademarks of Firefly Mobile, Inc.

For more information visit www.fireflymobile.com.

Screen images are simulated. Actual screen images may vary between service providers.

Printed in USA

84-0001-005

SAFETY INFORMATION

Read and follow these guidelines. Not following these guidelines may be dangerous or illegal. Read the complete guide for more information.



Power up (turn on) safely. Use this phone only where wireless phones are permitted.



Interference. All wireless phones may be susceptible to interference, which could affect performance.



Turn off in hospitals. Follow any restrictions. Wireless devices can cause interference with medical equipment.



Turn off in aircraft. Wireless devices can cause interference in aircraft.



Qualified service. Only qualified technicians may repair this product.



Water resistance. This phone is not waterproof. Keep it dry.



Emergency calls. Make sure the phone is turned on and in service. Press and hold the emergency call button until **Emergency Call** or **Call 112** appears in the display. Press  to complete the call.

When using the features in this device, obey all laws and respect privacy and legitimate rights of others.

Network Services

To use this handset, you must obtain service from a wireless service provider. Your service provider may provide additional instructions for using network services on this phone. Some networks may have limitations that affect how you can use wireless services. Please ensure that voicemail is not included on your account as the Firefly phone does not support this functionality.

Charger and Enhancements

This handset uses an internal, rechargeable lithium-ion battery. When you disconnect a power cord, grasp and pull the plug, not the cord. For availability of approved chargers and enhancements, please check with your dealer.



Warning! Use only chargers and accessories approved by the manufacturer for use with this phone. Use of any other types will invalidate the warranty and may be dangerous.

MEET THE FIREFLY PHONE

Your new Firefly wireless phone is designed for kids. It is easy to use. Just press a couple of buttons to place a call. There is no need to remember numbers or dial. The special Phone Book makes this possible. It can hold up to 20 pre-programmed numbers. Use the parental control options to limit incoming and outgoing calls to the numbers in the Phone Book.

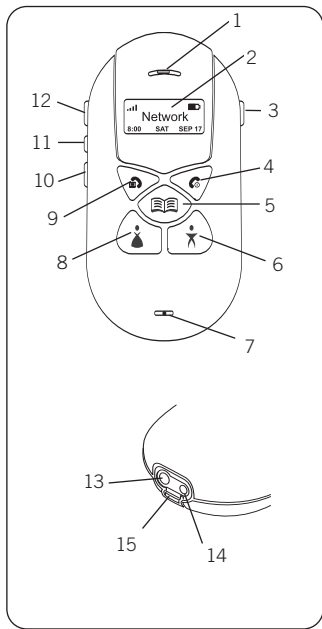

- 1 Earpiece.** Hold to ear when using the phone.
- 2 Display.** View status and menu information.
- 3 911 Assistance Button.** Press and hold to activate the emergency call function. **Emergency Call** or **Call 112** appears on the display.
- 4 End Key.** Press to end a call. Press and hold to turn the phone on or off.
- 5 Phone Book Call Key.** Press to view and call up to 20 pre-programmed numbers.
- 6 Dad Call Key.** Press to call a pre-programmed number.
- 7 Microphone.** Hold near mouth when using the phone.
- 8 Mom Call Key.** Press to call a pre-programmed number.
- 9 Send Key.** Press to answer or make a call. Press and hold to see the menus.
- 10 Volume Down Button.** Press to decrease earpiece or ring volume.
- 11 Firefly Fireworks™ Display Button.** Press to start the Firefly Fireworks™ display.
- 12 Volume Up Button.** Press to increase earpiece or ring volume.
- 13 Charger Port.** For charger cable.
- 14 Headset Port.** Plug your headset in here.
- 15 Accessory Hook.** Use to attach phone accessories.



PREPARE THE PHONE FOR USE

This phone requires a SIM card and a charged battery for operation.

Install a SIM Card

Your phone may already have a SIM card installed. If not, you must install a SIM card before setting up your phone. The SIM card (provided by your network service provider) contains the phone number for your phone and provides access to network service options.

Note: Contact your network service provider if you have problems with the SIM card or questions about your service.

1. Turn your phone off. Using your thumb, push up and hold the release button at the top of the back shell.
 - a. Use your fingers to pull the back shell off.
2. Turn the phone upside-down. Push the  and  keys with your thumbs and pull the front shell off with your fingers.
 - a. Be sure your fingers don't cover the tabs on the bottom of the front shell.
3. Pull the front shell off.
4. Slide the SIM card under the metal clip. Be sure the cut corner is lower left and the gold contacts of the SIM card are face down.*
5. Replace the front shell. Move the keypad into place, if needed.
6. Replace the back shell. Press the front and back shells together.

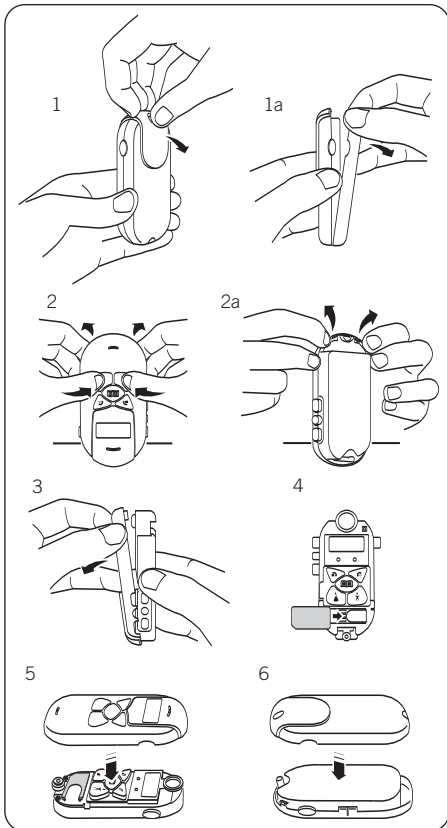

* Call Keys and Call Screening will only work if the SIM card is installed in a Firefly phone.

Charge the Battery

It will take about 2 hours to charge the internal battery for the first time. While charging, the tail lights flash and **Charging** appears on the display. The battery icon will indicate that the phone is charging.

To charge the battery:

1. Connect the charger to a standard AC wall outlet.
2. Plug the charger cable into the phone's battery port.

Note: After the initial charge, recharge the battery when the battery icon in the display reads low.

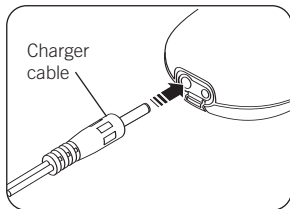

 **Warning!** Always use the charger supplied with your phone or one approved by the manufacturer. Other chargers may damage the phone and will void the warranty.

GETTING STARTED

After the SIM card is installed and the battery is charged, you are ready to begin the setup process.

Power On and Off

To turn on your phone, press and hold  for several seconds. The lights go on and the display activates. The phone will attempt to locate the wireless service.

Note: If the phone is not in a service area, **No Network** appears on the display.

To turn off your phone, press and hold  for several seconds. The display goes blank and the lights go off.

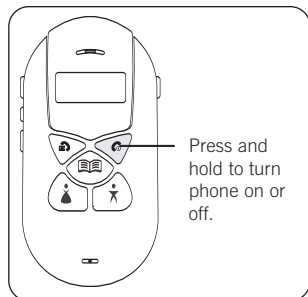

Display

The display area is activated when the phone is on and provides information about:

- Your wireless service.
- Signal strength.
- Battery status.
- Name and number of incoming/outgoing calls.
- Menu options and selections.

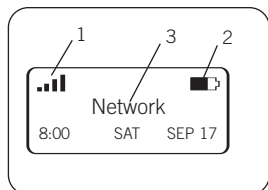

1. Indicates signal strength.

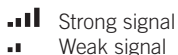

2. Indicates battery strength.

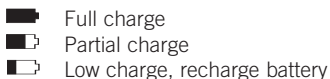

3. Text area.

MENUS

Use the menus to customize your phone and make it more fun for your child to use. For example, using the menus you or your child can:

- Change the Firefly Fireworks™ display animation.
- Select display colors and ring tones.
- Select a language for the display text.

In addition, several PIN-protected, parental control menus allow you to manage incoming and outgoing calls for your child.

To prepare the phone for use, complete the set-up tasks described in this section.

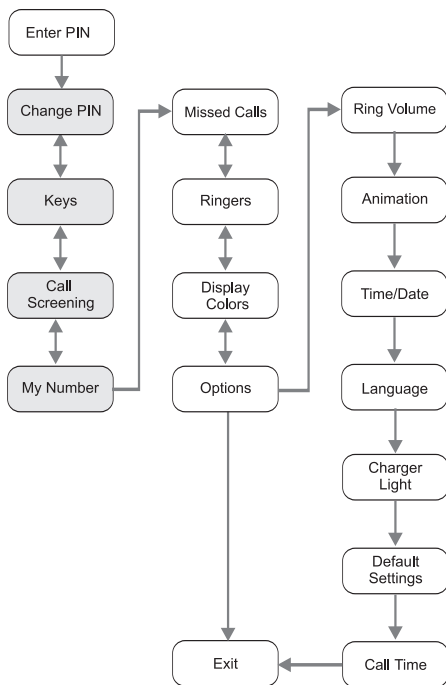

Gray = PIN-protected menu



Each menu controls a special operation or feature.

MENU	OPERATION/FEATURE
Enter PIN	Enter your PIN to access the PIN-protected menus.
*Change PIN	Set up a unique PIN.
*Keys	Assign names and telephone numbers to the Call Keys.
*Call Screening	Turn Call Screening on or off.
*My Number	See the phone number of your phone.
Missed Calls	See a list of unanswered calls.
Ringers	Select and assign special ring tones for each Call Key.
Display Colors	Change the background color of the display.
Options	Set/select the following options:
Ring Volume	Set the default ring volume.
Animation	Select the animation option for the display.
Time/Date	Set the time and date.
Language	Select the language used for display messages.
Charger Light	Turn the tail lights on or off when charging the battery.
Default Settings	Restore the phone to its original factory settings.
Call Time**	View the total cumulative call time of your phone.
Exit	Return to normal operation.

* Indicates a PIN-protected menu.

** The amount of network connection time you track on your timer may not equal the amount of time for which you are billed by your service provider. For billing information, please contact your service provider directly.

Menu Choices

In the menus, the , , and  keys are used to select the menu choices on the bottom line of the display. Press the menu key below the menu choice to perform the task.

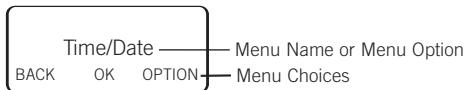

MENU CHOICE PRESS THE MENU KEY TO:

<	Scroll to previous item.
>	Scroll to next item.
BACK	Return to previous menu.
CANCEL	Cancel the current selection.
COLOR	View the next display color.
EDIT	Change/modify time, date, name, or number.
EXIT	Close the menus and return to normal operation.
KEY	Select the next Call Key.
LOAD	Load a name and number from the SIM card.
MORE	View additional options.
NEXT	View next screen or menu.
NO	Reject current setting/selection.
OK	Accept current or selected setting/selection.
OPTION	View the next Option menu.
RING	Play the next ring tone choice.
SAVE	Apply current setting/selection.
SWITCH	Switch between options.
YES	Accept current setting/selection.

Note: Not all menu choices are available in each menu.

Using the Menu

When you access the menus, you will be prompted to enter a 4-digit PIN. If you skip the PIN, you will see only the menus that are not PIN-protected. If you enter a PIN, you will see all the menus.

To access the menus:

1. Press and hold  until you see **Enter PIN**.
2. Press SKIP to access the menus that are not PIN-protected.
3. Use BACK and NEXT to move through the menus. Use OK to select options.
4. To exit the menus, continue to press NEXT until you see the **Exit** screen, then press EXIT.

To access the PIN-protected menus:

1. Press and hold  until you see **Enter PIN**.
2. Press ENTER.
3. Enter your PIN. (default PIN = 1 2 3 4)
 - a. Press → to scroll to the first number and press OK. An asterisk (*) appears on the top line.
 - b. Scroll to the next number and press OK. Repeat until you have entered the PIN.
 - c. The screen will automatically scroll to Done. Press OK. If the PIN is accepted, you will see **Change PIN**.
4. Press YES to change the PIN number. (Press NO to go to the next menu without changing the PIN.)
 - a. Scroll to the number and press OK. An asterisk (*) appears on the top line.
 - b. Scroll to the next number and press OK. Repeat until you have entered the PIN. Make sure there are 4 asterisks (****) on the top line.
 - c. The screen will automatically scroll to Done. Press OK. **Saved** indicates the new PIN was accepted.

Note: If you change the default PIN, remember to save a copy of the new PIN in a secure place.
5. Press YES to change the PIN again or press NO to move to the next menu.
6. Use BACK and NEXT to move through the menus. Use OK to select options.

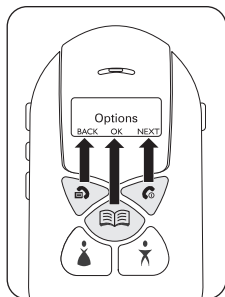

SETTING UP THE PHONE

Before using the phone, you should:

- Set the time and date if not automatically set by your service provider.
- Set up the Mom, Dad, and Phone Book keys.*
- Turn Call Screening ON (optional).*

Note: When Call Screening is ON, the phone only accepts calls from numbers in the Mom, Dad, and Phone Book keys. When Call Screening is OFF, the phone accepts all incoming calls.

Set the Time and Date

Most service providers automatically set the time and date for the phone. If your time and date are not correct, follow these steps:

1. Scroll through the menus until you see **Options**.

Press OK.

2. Press OPTION until you see **Time/Date**. Press OK.

3. Press EDIT to see the date options:

- a. Press <- and -> to scroll to the current year, then press OK.

- b. Scroll to the current month. Press OK.

- c. Scroll to today's date. Press OK.

- d. Scroll to Done. Press OK.

- e. Check the date. Press EDIT if you need to change the date.

- f. Press OK to save the date.

4. Press EDIT to see the time options:

- a. Scroll to the current hour. Press OK.

- b. Scroll to the current minute. Press OK.

- c. Scroll to am or pm and press OK. Scroll to Done and press OK.

- d. Check the time. Press EDIT if you need to change the time.

- e. Press OK to save the time.

5. Press BACK to return to the **Options** menu, then press NEXT until you see EXIT.

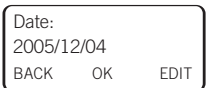
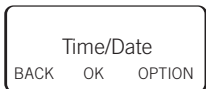
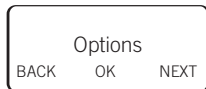

6. Press EXIT to exit the menus and return to the normal display.



* Call Keys and Call Screening will only work if the SIM card is installed in a Firefly phone.

Set Up the Call Keys

There are 3 Call Keys:*

- Two speed dial keys,  and . Each calls a single number. By default, these keys are called Mom and Dad.
- The  key is used to access up to 20 names and numbers. Use the PIN-protected **Keys** menu to change the names and numbers assigned to the three Call Keys.

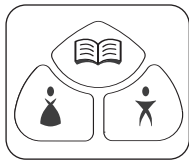

To set up the and Call Keys:

1. Press and hold  to access the menus. Enter your PIN.
2. Scroll through the menus to **Keys**. Press OK. A Call Key name appears on the display.
3. Press OK to select this Call Key. (Press KEY again to select another Call Key.)
4. View the Call Key's current number on the display screen.
5. Press EDIT to change that number (or press OK to keep it).
6. Press DEL to erase the current phone number, then press EDIT to add a new number.

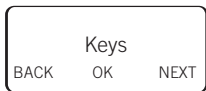

- a. Press <- and -> to scroll to the first digit of the number, then press OK. The digit appears on the top line.
- b. Scroll to the next digit and press OK. Repeat until the entire number is on the top line.

Tip: Scroll to Del and press OK to delete a digit.

- c. Scroll to Done and press OK. The number is displayed. Press OK to save this number.
7. The Call Key name will appear on the display.
 8. Press EDIT to change that name (or press OK to keep it).
 9. Press DEL to erase the current name, then press EDIT to add a new name.

- a. Press <- and -> to scroll to the first letter of the new name, then press OK. The letter appears on the top line.

Tip: Scroll to Del and press OK to delete a letter.

- b. Scroll to the next letter and press OK. Repeat until the entire name is on the top line.
 - c. Scroll to Done and press OK. The name is displayed. Press OK to save the name and return to the **Keys** menu.
10. Repeat steps 3-11 to set up the other Call Key.
 11. Press BACK to return to the **Keys** menu, then press NEXT until you see EXIT.
 12. Press EXIT to exit the menus and return to the normal display.

To set up the Phone Book key:

The Phone Book can hold a maximum of 20 names and numbers. Setting up the names and numbers in the Phone Book is similar to setting up the Mom and Dad keys.

Use the PIN-protected **Keys** menu to add, change, and delete names and numbers in the Phone Book.

- **Add.** Enter names/numbers.
- **Edit.** Modify names/numbers already in the Phone Book.
- **Delete.** Remove names and numbers from the Phone Book.

To add a name/number to the Phone Book:

1. Press and hold  to access the menus. Enter your PIN.
2. Scroll to **Keys** and press OK. Press KEY until you see **Phone Book**. Press OK.
3. You will see **Add**. Press OK.

- a. Press EDIT to add a name.
- b. Use ← and → to scroll to a letter and press OK to put it on the top line.

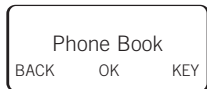

Tip: Scroll to Del and press OK to delete a letter.

- c. Scroll to the next letter and press OK. Repeat until the entire name is on the top line of the display.
 - d. Scroll to Done and press OK. The name will appear on the display. Press OK to save the name.
 - e. Press EDIT to enter the number.
 - f. Scroll to the desired digit and press OK to put the digit on the top line.
 - g. Scroll to the next digit and press OK. Repeat until the entire number is on the top line.
 - h. Scroll to Done and press OK.
 - i. Press OK to confirm.
4. Press OK to enter another name/number and repeat step 3.
 5. Press BACK to return to the **Keys** menu, then press NEXT until you see EXIT.
 6. Press EXIT to exit the menus and return to the normal display.

To edit the Phone Book:

1. Press and hold  to access the menus. Enter your PIN.
2. Scroll to **Keys** and press OK. Press KEY until you see **Phone Book** and press OK.
3. Press OPTION until you see **Edit**, then press OK.
 - a. Press -> to scroll to the name and number you want to edit and press EDIT to select.
 - b. Press EDIT again to confirm or press OK to leave the name unchanged. (*Skip to Step f.*)
 - c. Use <- and -> to scroll to a letter and press OK to put it on the top line.
Tip: Scroll to Del and press OK to delete a letter.
 - d. Scroll to the next letter and press OK. Repeat until the entire name is on the top line of the display.
 - e. Scroll to Done and press OK. Press OK again to confirm. The number will appear on the display.
 - f. Press EDIT to change the number or press OK to leave the number unchanged.
 - g. Scroll to the desired digit and press OK to put the digit on the top line.
 - h. Scroll to the next digit and press OK. Repeat until the entire number is on the top line.
 - i. Scroll to Done and press OK.
 - j. Press OK to confirm.
4. Press OK to enter another name/number and repeat step 3.
5. Press BACK to return to the **Keys** menu, then press NEXT until you see EXIT.
6. Press EXIT to exit the menus and return to the normal display.

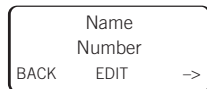



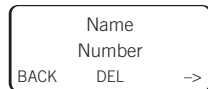

To delete a name/number from the Phone Book:

1. Press and hold  to access the menus. Enter your PIN.
2. Scroll to **Keys** and press OK. Press KEY until you see **Phone Book** and press OK.
3. Press OPTION until you see Delete. Press OK.
4. Use -> to scroll to the name/number you want to delete.
5. Press DEL to delete the Phone Book entry. Press YES to confirm that you want to delete this Phone Book entry.
6. Press BACK to return to the **Keys** menu, then press NEXT until you see EXIT.
7. Press Exit to exit the menus and return to the normal display.



Load Call Key Numbers from the SIM

Note: Your SIM card can be pre-programmed with names and numbers from any GSM cellular handset. These names and numbers can then be loaded into the  and  Call Keys on your Firefly phone.*

1. Press and hold  to access the menus. Enter your PIN.
2. Scroll through the menus to **Keys**. Press OK.
3. Press KEY to scroll to the  or  Call Key and press OK.
4. Press LOAD.
 - a. Press → to scroll through the names and numbers on the SIM.
 - b. Press OK when you see the desired name and number.
 - c. Press OK to save the name/number.

Tip: Press EDIT if you need to change the number.
 - d. Press OK again to confirm the name/number and finally to return to **Keys**.
5. Repeat steps 3 and 4 to load another name and number.

Call Screening

When Call Screening is OFF, the phone will accept all incoming calls. When Call Screening is ON, the phone will accept calls only from the names/numbers assigned to the Call Keys and in the Phone Book. The default setting for Call Screening is OFF.

After you activate the Call Screening option, test it to make sure it is working properly before giving the phone to your child.*

To turn Call Screening on or off:

1. Press and hold  to access the menus. Enter your PIN.
2. Scroll through the menus to **Call Screening**. Press OK.
3. Press SWITCH to toggle between Call Screen ON and Call Screen OFF.
4. Press OK to accept the setting.

To test Call Screening, call your phone from two different phones:

- Call from a phone that is listed in the Phone Book. Your phone should ring.
- Call from a phone that is not in the Phone Book. Your phone should not ring.

If Call Screening is not working:

- Check the Phone Book to make sure the number of the "approved phone" is in the Phone Book.
- Check the Call Screening menu to make sure the Call Screening is ON.

* Call Keys and Call Screening will only work if the SIM card is installed in a Firefly phone.

CUSTOMIZING THE PHONE

You have finished the basic setup and the phone is ready to use. However, you may also want to set/select other features, including:

- Set ring tones for each Call Key.
- Set display colors for each Call Key.
- Select an animation that will run during the Firefly Fireworks™ display.

Set the Ring Tones

To assign a special ring tone to a Call Key:

1. Scroll through the menus until you see **Ringers**. Press OK.
2. Press KEY until you see the Call Key you want. Press OK.
3. Listen to the first ring tone. Press RING to hear another ring tone. Press OK to assign the ring tone to the Call Key. Saved appears on the display and you will return to the **Ringers** menu.
4. Repeat steps 2 and 3 to assign a ring tone to each Call Key.
5. Press BACK to return to the **Ringers** menu, then press NEXT until you see EXIT.
6. Press EXIT to exit the menus and return to the normal display.

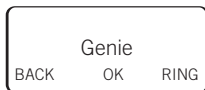
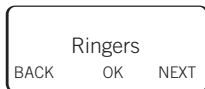

Select Display Colors

To assign a background display color to a Call Key:

1. Scroll through the menus until you see **Display Colors**. Press OK.
2. Press KEY until you see the Call Key you want. Press OK.
3. Look at the display color. Press COLOR to see more choices. Press OK to assign the color to the Call Key. Saved appears on the Display and you will return to the **Display Colors** menu.
4. Repeat to assign a display color to another key.
5. Press BACK to return to the **Display Colors** menu, then press NEXT until you see EXIT.
6. Press EXIT to exit the menus and return to the normal display.

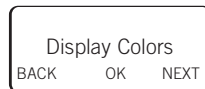

Select an Animation

The animation you select will play during the Firefly Fireworks™ display.

To select an animation:

1. Scroll through the menus until you see **Options**. Press OK.
2. Press OPTION until you see **Animation**. Press OK.
3. Press MORE until you see the animation name you want, then press OK. Saved will appear on the display and you will return to the **Animation** menu.
4. Press BACK to return to the **Animation** menu, then press NEXT until you see EXIT.
5. Press EXIT to exit the menus and return to the normal display.

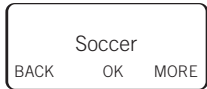

Change the Charger Lights



To turn the tail lights on or off while the battery is charging:



1. Scroll through the menus until you see **Options**. Press OK.
2. Press OPTION until you see **Charger Light**. Press OK.
3. Press SWITCH to turn the lights on or off, then press OK to save the setting
4. Press BACK to return to the **Options** menu, then press NEXT until you see EXIT.
5. Press EXIT to exit the menus and return to the normal display.

USING THE PHONE



Now that you have set-up and customized the phone, it's time to use it for the first time.

Make a Call

To make a call using  or :



1. Press  or .
2. Check the name on the display.

Note: If it is not correct, you need to reprogram this key.

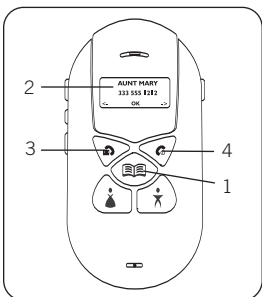
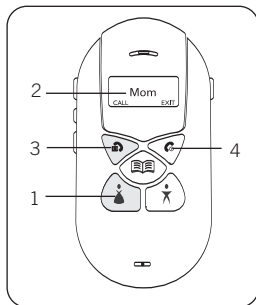
3. Press  to place the call.
4. Press  to end the call.





To make a call using the Phone Book:

1. Press .
2. Use ← and → to scroll to the name/number you want to call. Press OK. The name will appear on the display.
3. Press  to place the call.
4. Press  to end the call.

Make an Emergency Call

1. Press and hold the 911 assistance button for 3 seconds. Release the button when you see **Emergency Call** or **Call 112** on the display.

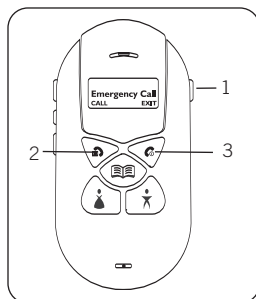

Note: Do NOT complete the call unless this is an actual emergency. 112 is the international emergency telephone number for GSM mobile networks. In the United States, dialing 112 on a mobile phone is the same as dialing 911.

2. Press  to complete the call.
3. Press  to end the call.

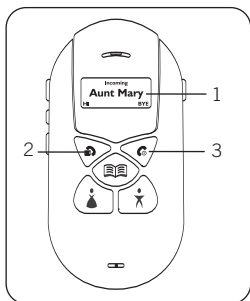

Answer a Call





1. Check the name and/or number on the display.
2. Press  to answer the call.
3. Press  to end the call.

Answer a Call Waiting Call

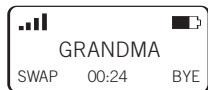
If the phone is in use and another call comes in, use this procedure to put the first call on hold, answer the second call, and switch between callers.



1. Press  to answer the new call. The first caller will be put on hold.
2. Check the display and press SWAP to switch between calls.
3. Press  to end the call. The call on hold will become active. Press  again to end the active call.

Send Numbers During a Call

If, during a call, you need to send numbers (DTMF tones) to the network or to an answering machine, use this procedure.

1. Press TONE to access the number entry display.
2. Use <- and -> to scroll to the desired number, then press OK to send the number.
3. Repeat to send as many as needed.
4. Scroll to Done and press OK after all numbers have been sent.

Adjust the Volume

To adjust the volume during a call:

- Press the Volume up button to increase the volume.
- Press the Volume down button to decrease the volume.

To adjust the volume of the ring:

The ring can only be adjusted when the phone is not in call mode.

- Press the Volume up button to increase the volume of the ring tone.
- Press the Volume down button to decrease the volume of the ring tone.

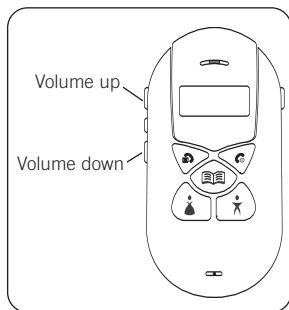

View the Missed Calls List

Only calls that are missed while the phone is powered on will appear on the Missed Calls list.

To see a list of unanswered calls:

1. Scroll through the menus to **Missed Calls**. Press OK.
2. Press → to scroll through the list. Press BACK to return to the menus.

View Call Timer*

To see the total call time for your phone:

1. Scroll through the menus until you see **Options**. Press OK.
2. Press OPTION until you see **Call Time**. Press OK. The call time format is hh:mm:ss.
3. Press OK.

* The amount of network connection time you track on your timer may not equal the amount of time for which you are billed by your service provider. For billing information, please contact your service provider directly.

Firefly Fireworks™ display and other lights

The phone lights up when it is turned on and when the Firefly Fireworks™ display button is pressed. The lights go off after 15 seconds or when the phone is turned off.

- Display background color changes during the Firefly Fireworks™ display. It is red when the 911 assistance button is pressed.
- Call Keys lights glow when pressed and when receiving calls.
- Tail lights flash when the battery is charging and periodically when the phone is on.

Press the Firefly Fireworks™ display button to see a 30-second Firefly Fireworks™ display. All the lights flash, the animation runs, and the display changes colors. The Firefly Fireworks™ display also plays periodically whenever the phone is powered on.

Your child can change the light color for each Call Key, select an animation for the display, and activate/deactivate the Firefly Fireworks™ display option.

Note: See *Customizing the phone* for more information.

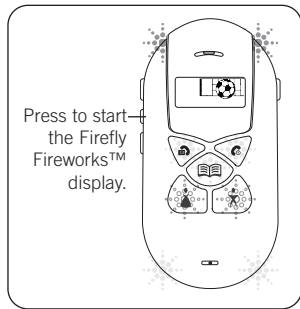

Attach the Backpack Clip

The backpack clip is a convenient accessory that your child can use to clip the phone to a backpack or other item.

1. Detach the 2-piece plastic clip.
2. Thread the string loop through the accessory hook (located under the battery charger port).
3. Insert the plastic clip through the loop and pull it tight to secure.
4. Reattach the 2-piece plastic clip.
5. Use the backpack clip to secure the phone to a backpack, belt loop, or similar item.

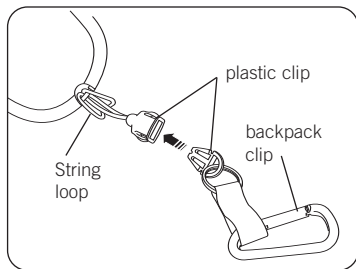

HELP YOUR CHILD USE THEIR PHONE

Now it's time to show your child how to use and take care of their phone.

Depending on the age of your child, you may want to read this user guide with your child. We recommend you show your child how to use their phone properly and allow him/her to demonstrate how to answer a call and place a call.

Explain how to take care of the phone and make arrangements for charging the battery on a regular basis. Depending on the age of the child, you may want to make sure an adult is responsible for charging the battery.

Finally, discuss with your child what to do in a situation that may require emergency assistance, and talk over scenarios that constitute an emergency.

MAINTENANCE AND TROUBLESHOOTING

Cleaning the phone

To clean the phone, use a soft cloth lightly moistened with water.

- The phone is NOT waterproof. Keep it away from water and rain.
- Do not use strong cleaning solutions or abrasive products as they may damage the plastic.

Use the Manual Reset Option

If the phone's display "freezes" or the keys won't work:

- Make sure a key isn't stuck in the keypad. If it is, gently move the key to free it.
 - You may need to reset the system using the manual override option.
1. Remove the rear and front covers. See *Install a SIM Card* for instructions.
 2. Use your fingernail to press the small reset key located on the left side of the circuit board under the keypad. This should cause the phone to turn off immediately.
 3. Replace the covers.
 4. Press and hold  to turn on the phone.

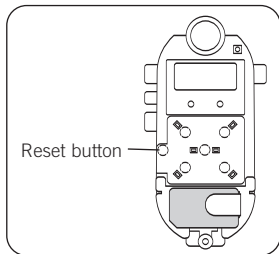

FIREFLY ONE-YEAR LIMITED WARRANTY

Firefly Mobile, Inc. ("Firefly") warrants that this cellular phone ("Product") will be free from defects in material and workmanship that result in Product failure during normal usage for ONE (1) YEAR from the date of purchase, according to the following terms and conditions:

1. The limited warranty extends only to the original purchaser ("You" or "Consumer") of the Product and may not be assigned or transferred to any subsequent purchaser or user. The limited warranty extends only to the Consumer who purchases the Product in the country for its intended sale.
2. Upon request from Firefly, You must prove the date of the original purchase of the Product by a dated bill of sale or dated itemized receipt.
3. During the limited warranty period, Firefly will repair or replace the Product, as Firefly determines, if its limited warranty applies. Firefly will be responsible for parts and labor to repair or replace the Product or defective parts of the Product.
4. The limited warranty does NOT cover defects in appearance, cosmetic, decorative or structural items, including framing, and any parts that do not affect the Product functions.
5. You shall bear the cost of shipping the Product to Firefly or to Firefly's authorized return center. Firefly shall bear the cost of shipping the Product back to You after completion of service, provided that repairs were required to be performed under this limited warranty.
6. Firefly's limited warranty does NOT apply if any of the following circumstances occurs:
 - a. The Product has been subjected to abnormal use or conditions, improper storage, exposure to moisture or dampness, unauthorized modifications, unauthorized connections, unauthorized repairs, misuse, neglect, abuse, accident, alteration, improper installation, or other acts that are not the fault of Firefly. This includes damage caused by shipping.
 - b. The Product has been damaged by external causes such as liquid, water, collision with an object, or from fire, flooding, sand, dirt, windstorm, lightning, or exposure to weather conditions; battery leakage; theft; blown fuse or improper use of any electrical source; computer or Internet viruses, bugs, worms, Trojan Horses, cancelbots; or connection to products not recommended for interconnection by Firefly.

- c. Defects or damages are caused by physical damage to the surface of the Product, including scratches or cracks in or to the outside housing or the LCD display.
 - d. You did not advise Firefly in writing of the alleged defects or malfunction of the Product within fourteen (14) days after the expiration of the warranty period.
 - e. The Product serial number plate or the accessory data code has been removed, defaced, or altered.
 - f. The defect or damage was caused by the defective function of the cellular system or by inadequate signal reception.
7. If damage or a defect develops during the limited warranty period, You must take the following step-by-step procedure:
- a. Return the Product to the place of purchase for repair or replacement. You must copy to another device and delete from the Product any sensitive data that You have stored in the Product prior to sending the Product for repair or replacement.
 - b. If return to the place of purchase is not convenient due to distance (more than 50 miles), You may contact the Customer Service Department of your cellular operator.
 - c. Ship the Product prepaid and insured at Your expense. Shipping expenses and expenses related to removing the Product from an installation are not covered under Firefly's limited warranty.
 - d. If the Product is covered by Firefly's limited warranty, Firefly will return the repaired or replaced Product to You at Firefly's expense. You are responsible for any expenses related to reinstallation of the Product.
 - e. Firefly will repair or authorize the repair of the Product under the limited warranty within 30 days of receipt of the Product. If Firefly cannot perform repairs covered under this warranty within 30 days, Firefly will provide a replacement Product or refund the purchase price.
 - f. If the Product is returned more than fourteen (14) days after the expiration of the limited warranty period, or if the Product is returned during the limited warranty period, but the problem with the Product is not covered under the terms and conditions of Firefly's limited warranty, Firefly will so notify You and provide an estimate (using Firefly's standard rates) of the charges You must pay to repair the Product, including return shipping charges. If You refuse the estimate Firefly will return the Product freight collect.

8. A repaired Product may consist of used components, some of which have been reprocessed. All used components comply with Product performance and reliability specifications.
9. Returning a Product for warranty repair or replacement will not extend the original warranty period.
10. Firefly's limit of liability under the warranty shall be the actual cash value of the Product at the time the Consumer returns the Product for repair. The cash value shall be determined by the price paid by the Consumer for the Product less a reasonable amount for usage. **Firefly shall not be liable for any other losses or damages.**
11. **The remedies set forth in this limited warranty are Your exclusive remedies for breach of warranty.**
12. **THE FOREGOING LIMITED WARRANTY IS THE CONSUMER'S SOLE AND EXCLUSIVE REMEDY AND IS IN LIEU OF ALL OTHER WARRANTIES, EXPRESS OR IMPLIED, INCLUDING ANY WARRANTY OF MERCHANTABILITY OR FITNESS FOR A PARTICULAR PURPOSE OR USE.**

IN NO EVENT SHALL FIREFLY BE LIABLE FOR SPECIAL, INCIDENTAL, CONSEQUENTIAL OR PUNITIVE DAMAGES, INCLUDING LOSS OF ANTICIPATED BENEFITS OR PROFITS, LOSS OF SAVINGS OR REVENUE, LOSS OF USE OF THE PRODUCT OR ANY ASSOCIATED EQUIPMENT, LOSS OF DATA, COST OF CAPITAL, COST OF ANY SUBSTITUTE EQUIPMENT OR FACILITIES, DOWNTIME, THE CLAIMS OF ANY THIRD PARTIES, INCLUDING CUSTOMERS, AND INJURY TO PROPERTY, RESULTING FROM THE PURCHASE OR USE OF THE PRODUCT OR ARISING FROM BREACH OF THE WARRANTY, BREACH OF CONTRACT, NEGLIGENCE, STRICT LIABILITY, OR ANY OTHER LEGAL OR EQUITABLE THEORY, EVEN IF FIREFLY KNEW OF THE LIKELIHOOD OF SUCH DAMAGES. FIREFLY SHALL NOT BE LIABLE FOR DELAY IN RENDERING SERVICE UNDER THE LIMITED WARRANTY, OR LOSS OF USE DURING THE PERIOD THAT THE PRODUCT IS BEING REPAIRED OR FOR LOSS OF DATA STORED IN THE PRODUCT.

13. Disclaimers of implied warranties are not enforceable in some jurisdictions, and some jurisdictions do not allow limitation of how long an implied warranty lasts, so the one year warranty limitation may not apply to You. This limited warranty gives You specific legal rights and You may also have other rights that vary from jurisdiction to jurisdiction.
14. This limited warranty is the entire warranty between Firefly and the Consumer, and supersedes all prior and contemporaneous agreements or understandings, oral or written, and all communications relating to the Product. No representative of Firefly or any third party seller of Firefly PRODUCTS may modify these terms, either orally or in writing.

FCC NOTICE AND SAR STATEMENT

This device complies with part 15 of the FCC Rules. Operation is subject to the following two conditions: (1) This device may not cause harmful interference, and (2) this device must accept any interference received, including interference that may cause undesired operation.

Any changes or modifications not expressly approved by Firefly Mobile, Inc. will void the user's authority to operate the equipment. Use only Firefly approved chargers.

Note: This equipment has been tested and found to comply with the limits for a Class B digital device, pursuant to part 15 of the FCC Rules. These limits are designed to provide reasonable protection against harmful interference in a residential installation. This equipment generates, uses and can radiate radio frequency energy and if not installed and used in accordance with the instructions, may cause harmful interference to radio communications. However, there is no guarantee that interference will not occur in a particular installation. If this equipment does cause harmful interference to radio or television reception, which can be determined by turning the equipment off and on, the user is encouraged to try to correct the interference by one or more of the following measures:

- Reorient or relocate the receiving antenna.
- Increase the separation between the equipment and receiver.
- Connect the equipment into an outlet on a circuit different from that to which the receiver is connected.
- Consult the dealer or an experienced radio/TV technician for help.

THIS PHONE MODEL HAS BEEN CERTIFIED TO BE IN COMPLIANCE WITH THE GOVERNMENT'S REQUIREMENTS FOR EXPOSURE TO RADIO WAVES.

Before a phone model is available to sale to the public, it must be tested and certified that it does not exceed government limits for exposure to radio frequency (RF) energy. Specific Absorption Rate (SAR) is a value that corresponds to the relative amount of RF energy absorbed by the user of a wireless phone. The Federal Communications Commission of the United States government and Health Canada set SAR limits. The limits include a safety margin designed to assure the safety of all persons, regardless of age and health. The maximum allowed SAR value set by the FCC is 1.6 W/kg. Tests for SAR values are conducted using FCC approved operating positions at the highest possible power levels. Although the SAR is determined at the highest certified power level, the actual SAR level of the phone while operating is likely well below the maximum value.

The highest SAR values as reported to the FCC for this model phone are in full compliance with FCC limits. This SAR compliance is limited to the specific accessories shipped with this phone. For body worn operation this device was tested with 0cm separation to the body. Third party belt-clips, holsters, and similar accessories containing metallic components should not be used.

For more information about RF exposure, visit the FCC website at www.fcc.gov.

Additional information on Specific Absorption Rates (SAR) can be found on the Cellular Telecommunications & Internet Association (CTIA) website:

http://www.ctia.org/wireless_consumers/health_and_safety/index.cfm

or the Canadian Wireless Telecommunications Association (CWTA) website:

<http://www.cwta.ca>

U.S. FOOD AND DRUG ADMINISTRATION

CONSUMER UPDATE ON MOBILE PHONES

Do wireless phones pose a health hazard?

The available scientific evidence does not show that any health problems are associated with using wireless phones. There is no proof, however, that wireless phones are absolutely safe. Wireless phones emit low levels of radiofrequency energy (RF) in the microwave range while being used. They also emit very low levels of RF when in the stand-by mode. Whereas high levels of RF can produce health effects (by heating tissue), exposure to low level RF that does not produce heating effects causes no known adverse health effects. Many studies of low level RF exposures have not found any biological effects. Some studies have suggested that some biological effects may occur, but such findings have not been confirmed by additional research. In some cases, other researchers have had difficulty in reproducing those studies, or in determining the reasons for inconsistent results.

What is the FDA's role concerning the safety of wireless phones?

Under the law, FDA does not review the safety of radiation-emitting consumer products such as wireless phones before they can be sold, as it does with new drugs or medical devices. However, the agency has authority to take action if wireless phones are shown to emit radiofrequency energy (RF) at a level that is hazardous to the user. In such a case, FDA could require the manufacturers of wireless phones to notify users of the health hazard and to repair, replace or recall the phones so that the hazard no longer exists.

Although the existing scientific data do not justify FDA regulatory actions, FDA has urged the wireless phone industry to take a number of steps, including the following:

- Support needed research into possible biological effects of RF of the type emitted by wireless phones;
- Design wireless phones in a way that minimizes any RF exposure to the user that is not necessary for device function; and
- Cooperate in providing users of wireless phones with the best possible information on possible effects of wireless phone use on human health. FDA belongs to an interagency working group of the federal agencies that have responsibility for different aspects of RF safety to ensure coordinated efforts at the federal level. The following agencies belong to this working group:
 - National Institute for Occupational Safety and Health

- Environmental Protection Agency
- Federal Communications Commission
- Occupational Safety and Health Administration
- National Telecommunications and Information Administration

The National Institutes of Health participates in some interagency working group activities, as well.

FDA shares regulatory responsibilities for wireless phones with the Federal Communications Commission (FCC). All phones that are sold in the United States must comply with FCC safety guidelines that limit RF exposure. FCC relies on FDA and other health agencies for safety questions about wireless phones.

FCC also regulates the base stations that the wireless phone networks rely upon. While these base stations operate at higher power than do the wireless phones themselves, the RF exposures that people get from these base stations are typically thousands of times lower than those they can get from wireless phones. Base stations are thus not the primary subject of the safety questions discussed in this document.

What kinds of phones are the subject of this update?

The term wireless phone refers here to hand-held wireless phones with built-in antennas, often called cell, mobile, or PCS phones. These types of wireless phones can expose the user to measurable radiofrequency energy (RF) because of the short distance between the phone and the user's head. These RF exposures are limited by Federal Communications Commission safety guidelines that were developed with the advice of FDA and other federal health and safety agencies. When the phone is located at greater distances from the user, the exposure to RF is drastically lower because a person's RF exposure decreases rapidly with increasing distance from the source. The so-called cordless phones, which have a base unit connected to the telephone wiring in a house, typically operate at far lower power levels, and thus produce RF exposures well within the FCC's compliance limits.

What are the results of the research done already?

The research done thus far has produced conflicting results, and many studies have suffered from flaws in their research methods. Animal experiments investigating the effects of radiofrequency energy (RF) exposures characteristic of wireless phones have yielded conflicting results that often cannot be repeated in other laboratories. A few animal studies, however, have suggested that low levels of RF could accelerate the development of cancer in laboratory animals. However, many of the studies that showed increased tumor development used animals that

had been genetically engineered or treated with cancer-causing chemicals so as to be pre-disposed to develop cancer in the absence of RF exposure. Other studies exposed the animals to RF for up to 22 hours per day. These conditions are not similar to the conditions under which people use wireless phones, so we don't know with certainty what the results of such studies mean for human health.

Three large epidemiology studies have been published since December 2000. Between them, the studies investigated any possible association between the use of wireless phones and primary brain cancer, glioma, meningioma, or acoustic neuroma, tumors of the brain or salivary gland, leukemia, or other cancers. None of the studies demonstrated the existence of any harmful health effects from wireless phone RF exposures. However, none of the studies can answer questions about long-term exposures, since the average period of phone use in these studies was around three years.

What research is needed to decide whether RF exposure from wireless phones poses a health risk?

A combination of laboratory studies and epidemiological studies of people actually using wireless phones would provide some of the data that are needed. Lifetime animal exposure studies could be completed in a few years. However, very large numbers of animals would be needed to provide reliable proof of a cancer promoting effect if one exists. Epidemiological studies can provide data that is directly applicable to human populations, but 10 or more years' follow-up may be needed to provide answers about some health effects, such as cancer. This is because the interval between the time of exposure to a cancer-causing agent and the time tumors develop - if they do - may be many, many years. The interpretation of epidemiological studies is hampered by difficulties in measuring actual RF exposure during day-to-day use of wireless phones. Many factors affect this measurement, such as the angle at which the phone is held, or which model of phone is used.

What steps can I take to reduce my exposure to radiofrequency energy from my wireless phone?

If there is a risk from these products--and at this point we do not know that there is—it is probably very small. But if you are concerned about avoiding even potential risks, you can take a few simple steps to minimize your exposure to radiofrequency energy (RF). Since time is a key factor in how much exposure a person receives, reducing the amount of time spent using a wireless phone will reduce RF exposure.

If you must conduct extended conversations by wireless phone every day, you could place more distance between your body and the source of the RF, since the

exposure level drops off dramatically with distance. For example, you could use a headset and carry the wireless phone away from your body or use a wireless phone connected to a remote antenna.

Again, the scientific data do not demonstrate that wireless phones are harmful. But if you are concerned about the RF exposure from these products, you can use measures like those described above to reduce your RF exposure from wireless phone use.

What about children using wireless phones?

The scientific evidence does not show a danger to users of wireless phones, including children and teenagers. If you want to take steps to lower exposure to radiofrequency energy (RF), the measures described above would apply to children and teenagers using wireless phones. Reducing the time of wireless phone use and increasing the distance between the user and the RF source will reduce RF exposure.

Some groups sponsored by other national governments have advised that children be discouraged from using wireless phones at all. For example, the government in the United Kingdom distributed leaflets containing such a recommendation in December 2000. They noted that no evidence exists that using a wireless phone causes brain tumors or other ill effects. Their recommendation to limit wireless phone use by children was strictly precautionary; it was not based on scientific evidence that any health hazard exists.

Where can I find additional information?

For additional information, please refer to the following websites:

Federal Communications Commission (FCC) RF Safety Program

<http://www.fcc.gov/oet/rfsafety>

U.S. Food and Drug Administration (FDA) Center for Devices and Radiological Health

<http://www.fda.gov/cdrh/consumer>

Cellular Telecommunications Industry Association

<http://www.wow-com.com>

National Radiological Protection Board (U.K.)

<http://www.nrp.org.uk>

World Health Organization (WHO) International EMF Project

<http://www.who.int/emf>